

# ASSEMBLY AND INSTALLATION INSTRUCTIONS

P0365

**WARNING:** TO AVOID RISK OF ELECTRICAL SHOCK, BE SURE TO SHUT OFF POWER WHILE INSTALLING OR SERVICING THIS FIXTURE.

**NOTES:** 1. Before installing, consult local electrical codes for wiring and grounding requirements.  
2. READ AND SAVE THIS INSTRUCTION.

## Hardware Package(included):

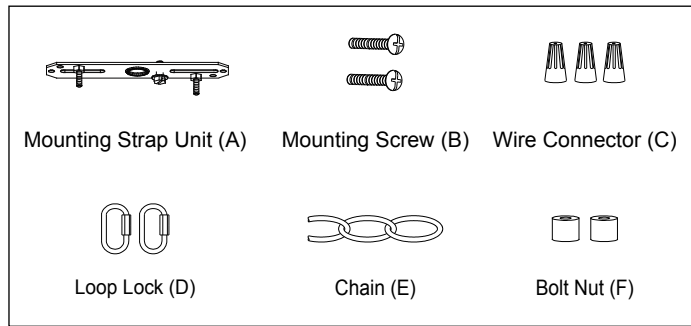

## Installation Steps

Turn off the power at fuse or circuit box.

1. Attach the mounting strap unit (A) to the outlet box by using two mounting screws (B).
  2. Attach the tube onto the threaded pipe and tighten it.
  3. Choose the length of the chain (E) you need, use pliers (not included) to open and remove excess chain section, then weave the fixture wire and the fixture ground wire through the chain (E) and canopy.
  4. Connect one end of the chain (E) with the loop by using a loop lock (D). Connect the other end of the chain (E) with the fixture loop by using another loop lock (D).
  5. Thread the fixture wire and fixture ground wire through mounting strap unit (A).
  6. Pull out the outlet wires and house ground wire from the outlet box. Make wire connections using the wire connectors (C):
    - The smooth wire (marked) from the fixture to the black wire from the power source.
    - The ridged wire (unmarked) from the fixture to the white wire from the power source.
    - Attach the fixture ground wire (bare wire) to the mounting strap unit (A) with the green ground screw, then connect it to the house ground wire with a wire connector (C).
- Carefully put all the wires back into the outlet box.

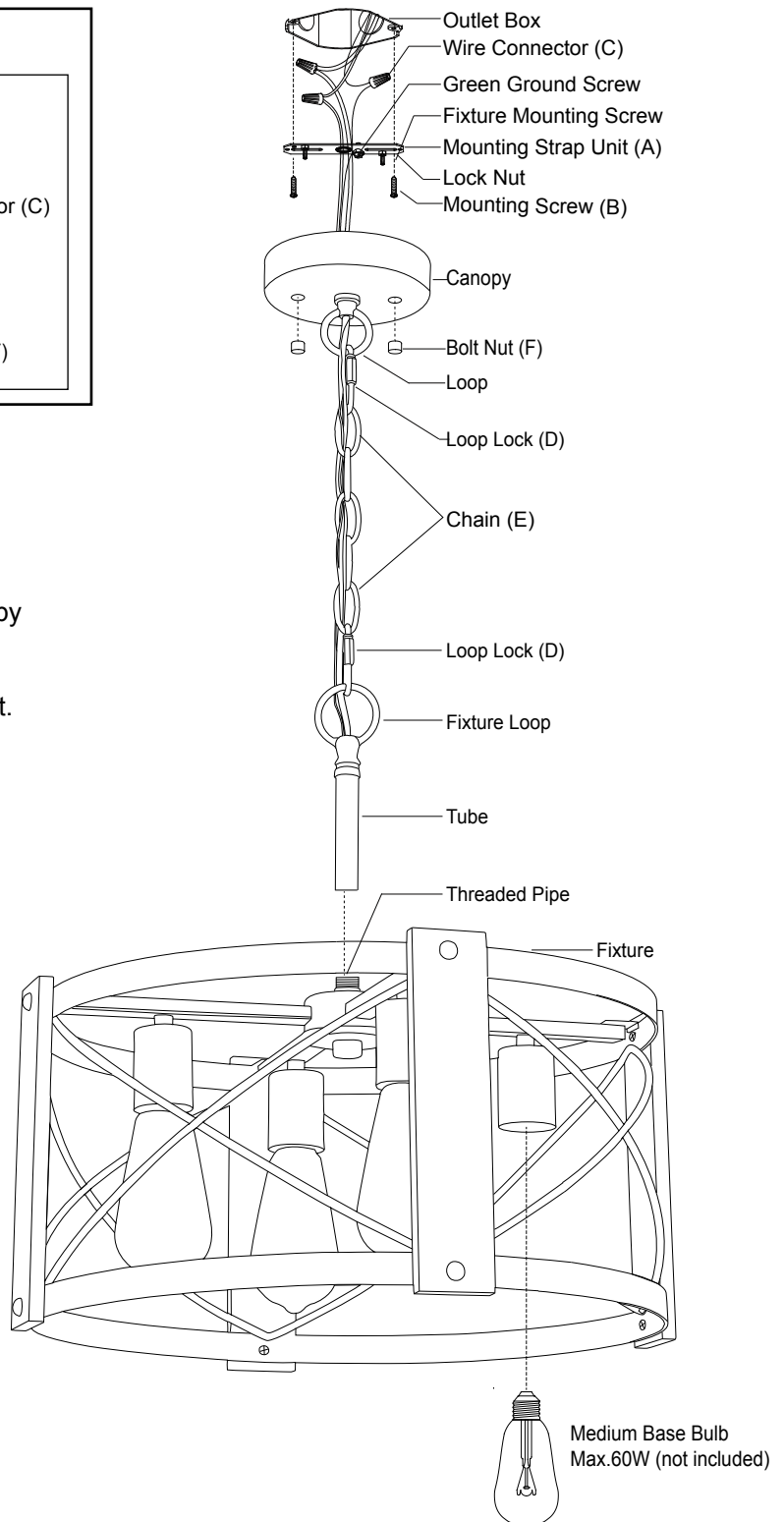

7. Attach the canopy to the mounting strap unit (A) and secure it with two bolt nuts (F) .







8. Install 4 x 60W Max. medium base bulbs (not included).

Check relamping label at socket area or packaging for maximum wattage allowed.

**Turn on the power at fuse or circuit box.**

The following parts are available for re-order if damaged or missing.

**Spare Parts List:**

			→ Assembly Kit 6450MM (1 SET)
Mounting Strap Unit (A)	Mounting Screw (B)	Wire Connector (C)	
			
Loop Lock (D)	Chain (E)	Bolt Nut (F)	

